

# Antique Outboard Club News

Southern California Chapter – Vol.5 March 2012

---

We had our last meet on March 10 at Puddingstone Lake. What a perfect day to be with old friends and see some great motors. The weather was perfect. Our host was Frank Fowler, who did a great job as usual. Was good to see two members we haven't seen at a meet for awhile... Miles Kapper and Steve Hurley. David Marotta did not attend as he has purchased a new boat to play with. Hope to see him at the next meet.

Our thoughts and prayers go out to George Kent and Les Gunnarson who recently both lost their brothers.

I called David Vaughn and he is at home now recovering from a bout with pneumonia. I know we all miss him at the meets and are praying for him to have a swift recovery.



Always happy Jack Holtwick



Lee Kinnel doing what he does best.



Very nice Waterwitch of Frank Fowler's. Can anyone identify this nice motorstand?



Frank Fowlers Neptune Mighty Mite on right, and my Clark Troller. Note the strange motor stand, do you think the county would approve ?.



George Kent and Host Frank Fowler.

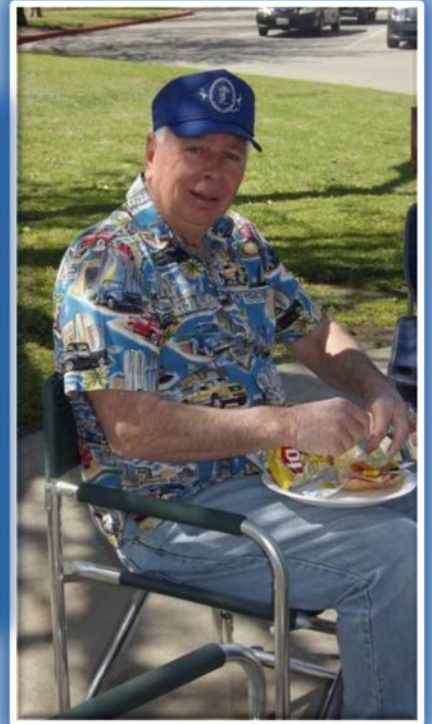

This is why Lee comes to meets.



Kip Fjeld on the left with our president Paul Brinkman



Everyone getting ready for something to eat.



The feast is on.



Our host Frank Fowler telling me how to take a picture.

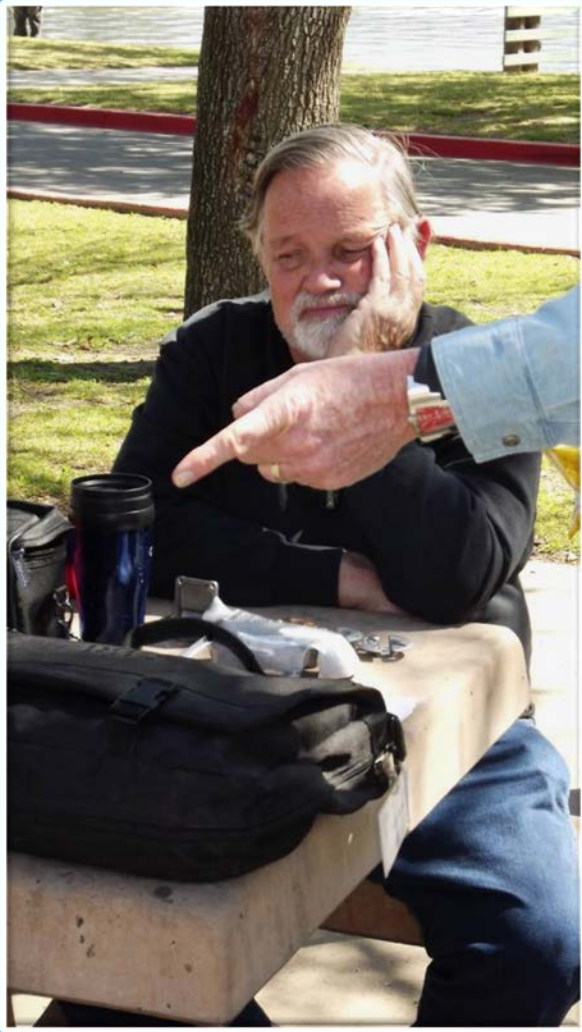

Who's arm is this ?



Booorring. Well Jack can't be happy all the time.

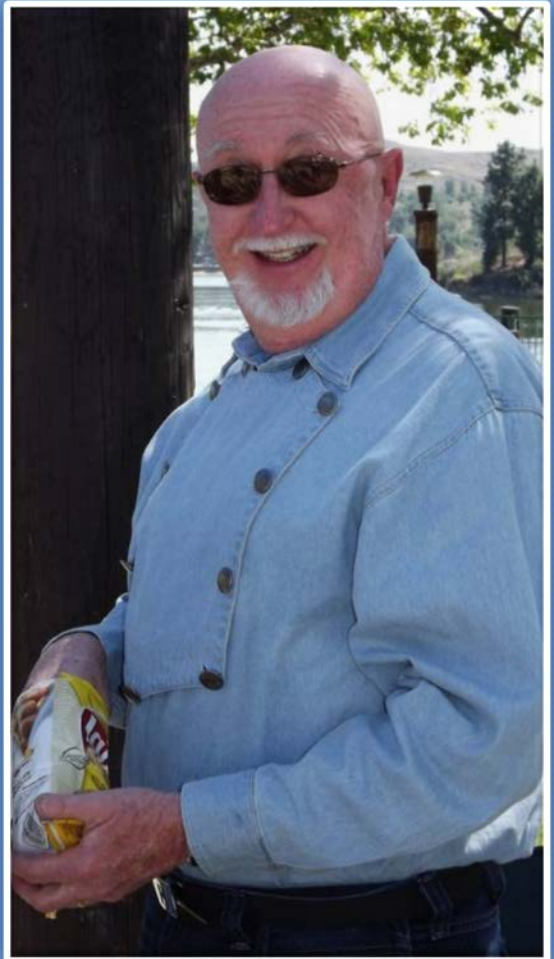

Good to see Steve Hurley at our meet , back with his sense of humor.

Some interesting articles On the next few pages.



# Gas Tank Cleaning for Outboard Motors

By: *Arnold W. Avery*

The restoration of antique outboard motors can be a challenging hobby. Most of the steps required for trouble shooting electrical, fuel (carburetion), and cooling systems, as well as scouting for missing parts, provide pleasure and satisfaction to serious collectors. However, I have never been able to enjoy cleaning rust, scale, or dried gasoline varnish from the inside of a tank using the common methods of soaking in solvents, shaking nuts and bolts or small stones, or probing around in there with a wire or rod. So how about a simpler method like just turning on an electric switch? Well almost, anyway.

The basic theory has been offered to us by an engineering group in southern California called EDGE & TA Branch 30 in an issue of The Gas Engine Magazine describing the removal of rust from engine parts. To a non-technical observer, their theory resembles an electroplating system in reverse, similar to a stripping circuit. The major contributors were M.L. Kliewer, Carl Bergman, Don Ross, and Jerry Wymore. In their article they kindly offer their formula to "all old engine lovers" who may have rust removal problems. I wish to emphasize that all credit for this project goes to these engineers and Branch 30, and we owe them our vote of thanks as collectors.

I have tested their system and it worked for me. It seemed logical to me to apply this same theory to the problem of removal of rust, scale, dirt, and old gasoline varnish from the inside of gasoline tanks made of any metal that conducts electricity. Since all of the items needed are available in most home workshops, the process is easily and inexpensively carried out in a few simple steps.

1. Assemble the following: 6 or 12 volt battery charger; plastic funnel; metal rod with length equal to twice depth of tank; cup of table salt; electricians tape; and clean fresh water.
2. Remove all residual gasoline vapor from inside of tank. (Very important safety precaution).
3. Fill tank with clean fresh water to level of filler cap.
4. Place plastic funnel in open filler hole in tank. (This insulates the anode from the tank) and permits adding salt to the tank contents).
5. Cover lower end of anode (metal rod) with electrical tape and lower anode through funnel to rest on bottom of tank. (tape prevents metal to metal contact between anode and tank).
6. Attach positive battery charger terminal to anode above funnel. Attach negative terminal to any metal part of tank.
7. Turn on power to battery charger, which probably will read zero amperes.
8. Add salt slowly to water in tank via plastic funnel, agitating slightly, until amperage reaches 8 to 10 amps. Water has now become an electrolyte, is conducting electricity, and cleaning action has begun.
9. Allow to cook for 10 minutes. Switch off power to charger. Remove contents of tank; check progress of cleaning action visually, and repeat steps 2 through 7 if necessary until inside of tank is clean and bright. A total of 20 minutes may be required. Do not "over cook." Keep in mind that metal is being removed from the inside of the tank.
10. When satisfied that tank is clean, rinse several times with clean fresh water, agitate, and repeat.
11. Dispose of sludge in appropriate manner.

Now Folks, it's up to you. Good luck and good collecting.

*(Note: The writer assumes no responsibility or liability for operator injury or damage to equipment resulting from carrying out this procedure.)*

## **Sparking Plug Attachment.**

The illustration herewith shows an ordinary sparking plug fitted with the Duplex attachment, the chief point of which is that it is designed to prevent the possibility of stoppage of the engine, due to the sooting up or fouling of the sparking plug points.

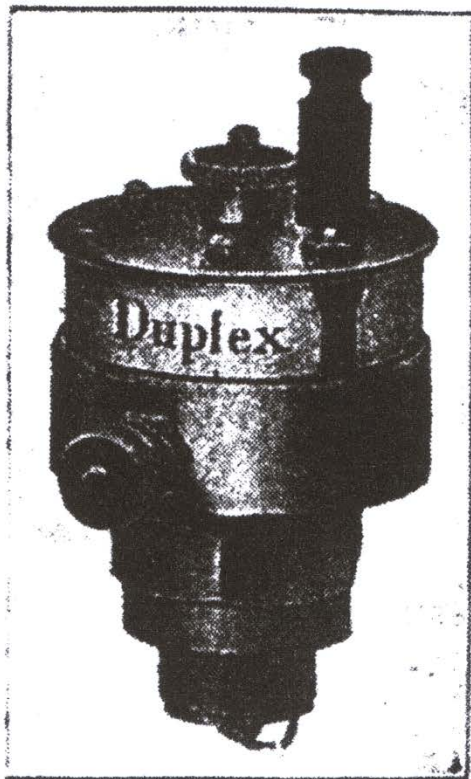

The attachment is not intended to be brought into operation when the plug is sparking normally, but to be used only in case of fouling taking place, the switch of the device being at all other times at rest in its pocket.

The lower milled thumb screw at the side on the illustration shows where the wire is attached. Should the plug become fouled and refuse to spark, the small switch handle shown on the top of the plug is pulled up. This breaks the direct current through the wire and brings the condenser

of the device into the circuit; and as this condenser rapidly becomes charged when the circuit is closed, the resultant discharge being too heavy to be carried wholly by the short circuiting carbon deposit, finds a path through the air across the fouled points, thus making the desired spark. It will be seen from the above description that the principle of the device is very simple, acting somewhat similar to a Leyden jar, and should prove useful as a prevention against what has always been a bugbear.

# *Mercury*

## **SPECIAL INTEREST GROUP**

*By Brian Werba*

Hello fellow Mercury fans. For those of you who have been having difficulty in dating your 20 c.i. 1947-1952 motors, fret no more. The following serial number/ year guide has been compiled from serial number information supplied from many A.O.M.C. members, of which I am truly grateful. Helpful members are what make this club great!

**KE-7 191001 through 214217 year 1947**  
**KE-7 242953 through 338135 year 1948**  
**KE-7 390193 through 391693 year 1949**

I have seen several ads for KE-7 motors offered for 1950 along with the KF-7 and KG-7 but I have not found any serial number information to substantiate this. Perhaps someone reading this has a "For-sure" 1950 model, please let me know so corrections can be made to this list.

**KF-7 360137 through 390185 year 1949**  
**KF-7 393944 through 402543 year 1950**

NOTE: KF-7's listed as KF-7 HD mostly fall between serial numbers: 402544 - 405293 one was found as low as in the 395800's.

**KG-7 391694 through 444887 year 1950**  
**KG-7 469702 through 493750 year 1951**  
**KG-7 499262 through 537512 year 1952**

NOTE: Numbers as high as 542000 may have been produced, please let me know if you have any.

**KG-7H 537513 thru 594627 year 1952**

NOTE: The preceding serial number/ dating guide is not fact positive, but is only a rough guide, or best guess listing based on information provided by fellow members.

As additional information becomes available, the list will be adjusted accordingly.

**Other Mercury News:** It has been brought to my attention that some very early KE-7 motors actually came from the factory (prototypes ?) with a cast one piece fuel tank/ trim ring assembly and bearing a brass identification tag. I would greatly be interested in hearing from anyone who may have one or has any information regarding these motors. I welcome anyone who has any Mercury products other than outboards (generators, pumps, etc.) to drop a line, as these too are likely to be of interest to our members. That's all for now.... HUG A MERC TODAY!



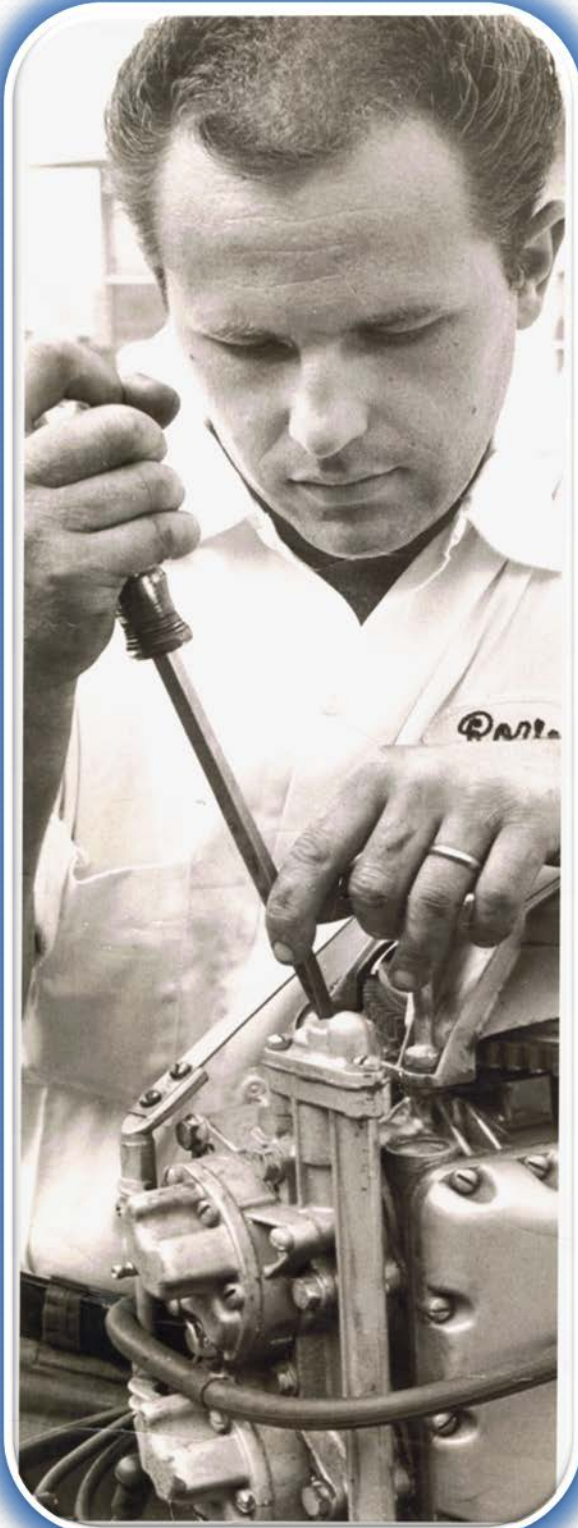

1962 Mercury Engines



The famous Mercury Hurricane

Who is this guy ? 

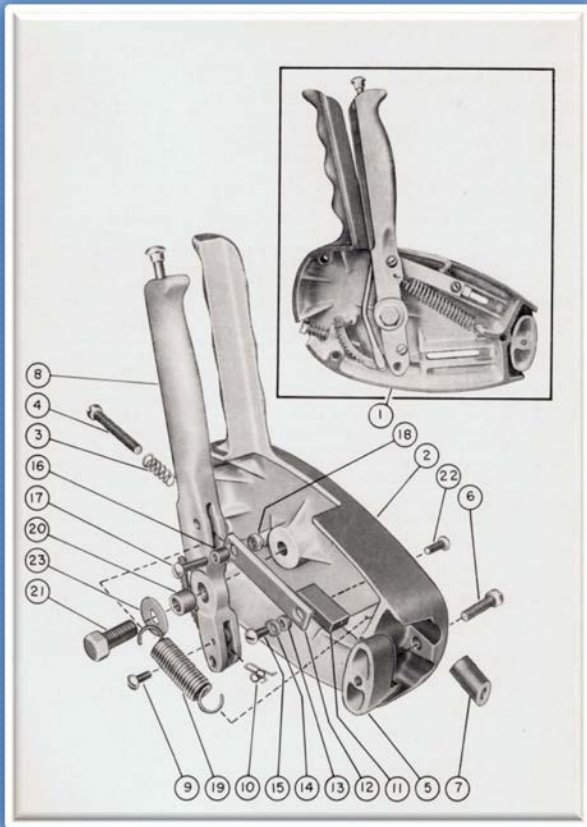

Mercury remote throttle control



Mercury Mark 40 1953

Our next meet is a very informal one. It's at Lake Arrowhead along with the Wooden Boat Club and the Woody Car Club, on Saturday, June 2nd . Bring your motors and stands to display, and also bring a chair.

We will have our regular meet on July 14<sup>th</sup> at Mission Bay in San Diego. Directions and a reminder will be sent out to you at a later date.

It was decided at the last meet to have our September meet at Lake Castaic, as we have a lot of members from LA. and Santa Barbara Counties.